

3212 JH4

DC axial compact fan



ebm-papst St. Georgen GmbH & Co. KG

Hermann-Papst-Straße 1

D-78112 St. Georgen

Phone +49 7724 81-0

Fax +49 7724 81-1309

info2@de.ebmpapst.com

www.ebmpapst.com

Nominal data

Type	3212 JH4	
Nominal voltage	VDC	12
Nominal voltage range	VDC	6 .. 13.8
Speed	min ⁻¹	13000
Power input	W	50
Min. ambient temperature	°C	-20
Max. ambient temperature	°C	70
Air flow	m ³ /h	280
Sound power level	B	8.2
Sound pressure level	dB(A)	73

ml = max. load · me = max. efficiency · rfa = running at free air · cs = customer specs · cu = customer unit
Subject to alterations



Technical features

Dimensions	92 x 92 x 38 mm
General description	<p>Particular design features:</p> <p>Rigid compression curve for high air flow at high counterpressure.</p> <p>Innovative impeller with winglets for low noise.</p> <p>Optional Vario-Pro: Highly flexible software configuration for the fan ensures an easily customisable solution to meet the individual requirements of your application.</p> <p>General features:</p> <p>Material: fibreglass-reinforced plastic. Impeller PA, housing PBT.</p> <p>Electronic commutation completely integrated.</p> <p>Protected against reverse polarity and locking.</p> <p>Connection via single strands AWG 24 (H3 and H4: AWG 22), TR 64, bared and tin-plated.</p> <p>Air exhaust over bars. Rotational direction clockwise looking at rotor.</p> <p>Mass: 240 g (H3 and H4: 280 g).</p>
Connection line	Single strands AWG 22, TR 64, bared and tin-plated.
Direction of rotation	Right, looking at rotor
Direction of air flow	Air exhaust over bars
Bearing	Ball bearings
Lifetime L10 at 40 °C	60000 h
Lifetime L10 at maximum temperature	30000 h
Mass	0.280 kg
Housing material	Fiberglass-reinforced PBT plastic
Material of impeller	Fiberglass-reinforced PA plastic
Motor protection	Protected against reverse polarity and locking.
Approval	VDE, CSA, UL

Product drawing

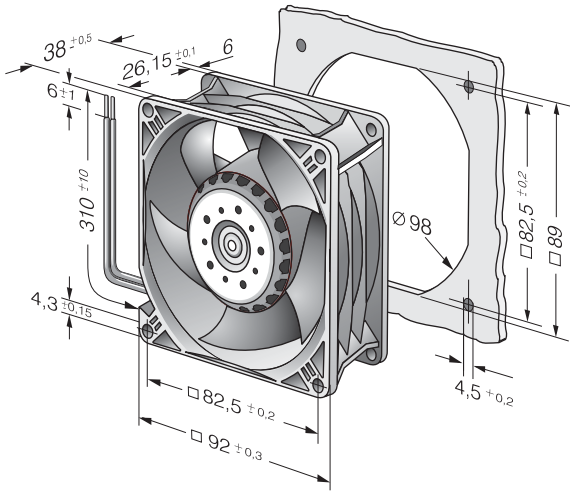

Charts: Air flow

